



Outdoor PTZ

Mounting on the Ceiling Using Pendant Mount

Installation Guide

For Models:

I93, I94, I95, I96, KCM-8211





2013/12/03

Table of Contents

- Mounting Solutions..... 3**
- Straight Tube Installation Procedures 4**
 - Step 1: Unpack the Camera 4**
 - Step 2: Install the Straight Tube 6**
 - Optional: Add Extension Tube(s)..... 6
 - Step 3: Install the Camera..... 7**
 - Step 4: Connect the Cables 9**
 - How to Waterproof the Cable Using the Cable Gland 10
 - How to Waterproof the Cable Using the Conduit Gland 14
- Straight Tube with Junction Box Installation Procedures 18**
 - Step 1: Unpack the Camera 19**
 - Step 2: Unpack the Junction Box..... 20**
 - Step 3: Drill the Holes on the Ceiling..... 21**
 - Step 4: Waterproof the Cables..... 21**
 - Step 5: Install the Junction Box 23**
 - Step 6: Install the Straight Tube 24**
 - Optional: Add Extension Tube(s)..... 24
 - Step 7: Install the Camera..... 25**
 - Step 8: Connect the Cables 26**
- Appendices 28**
 - How to Install Extension Tubes 28**
 - How to Use the Power Adapter (For I9x Models) 29**
 - How to Attach the Safety Wire Strap (For I9x Models) 30**
- Safety Information..... 32**

Mounting Solutions

If the camera will be installed on a hard ceiling using pendant mount, consider the following options:

Mounting Solution	Cabling Solution	Must Drill a Hole on the Ceiling
Straight Tube Installation	Cables go through the ceiling.	Yes
	PMAX- 0102 	
Straight Tube with Junction Box	The cables and the bundled power adapter are housed inside the junction box. The cables go out the junction box enclosed in a flexible conduit. The flex conduit can pass through the ceiling or be routed along the ceiling.	Yes / No
	PMAX-0102 PMAX-0700   	

Straight Tube Installation Procedures

Perform the following procedures to install the camera onto a hard ceiling using pendant mount with cables passing through the ceiling. You must be able to access inside the ceiling to complete the cable connections.

The bundled power adapter and power cord, approximately 200 cm in length, are not waterproof and must be protected indoors. Therefore with this type of installation, it is recommended to use a high PoE injector (purchased separately) to connect the camera to the power outlet and the network.

Before installation, prepare the tools and equipment which are not supplied with the mounting accessory:

- Exterior-grade Ethernet Cables (for use with cable gland)
- High Power-over-Ethernet (PoE) Injector
- Waterproof Tape

Step 1: Unpack the Camera

NOTE: To avoid scratches or leaving fingerprints on the dome cover, it is recommended to retain the plastic covering the dome cover until the camera is completely installed.

1. Loosen the four screws using the bundled Allen wrench.



- Carefully lift the camera cover and place it aside.

NOTE: The cover is attached to the camera by a metallic wire; do not abruptly lift the cover.



- Remove the outer and inner Styrofoam.



Outer Styrofoam



Inner Styrofoam

- Attach the camera cover.
Align the cover screws to the screw holes on the camera (as marked on the illustration) and secure the screws using the bundled Allen wrench.



Step 2: Install the Straight Tube

NOTE: Before installation, make sure that the ceiling can bear more than the total weight of the camera and the mounting accessories.

1. Using the drill template (included in the straight tube package), mark and drill the screw holes and the conduit hole location on the ceiling. The conduit hole is where the cables will pass through the ceiling.

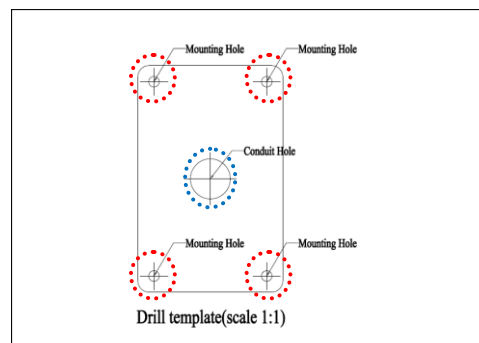

2. Attach the straight tube onto the ceiling using four (4) screws (purchased separately).

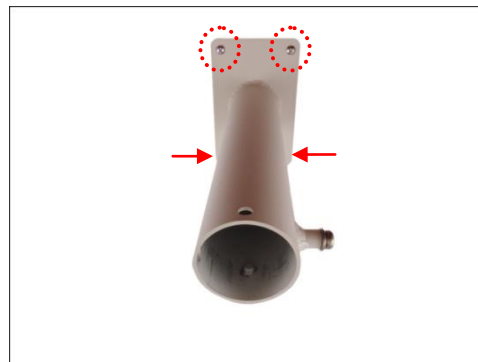

Optional: Add Extension Tube(s)

If the straight tube is not long enough, add one or more extension tubes (purchased separately).

If more than one extension tubes will be used, use extension cables, like network cables (not included in the package) to extend the length of the pre-installed camera cables. See [How to Install Extension Tubes](#) on page 28.

Step 3: Install the Camera

1. Insert the camera cables through the straight tube, extension tube (if any), and through the conduit hole on the ceiling.



2. Align the slot on the camera to the tab inside the straight tube and insert the top of the camera.

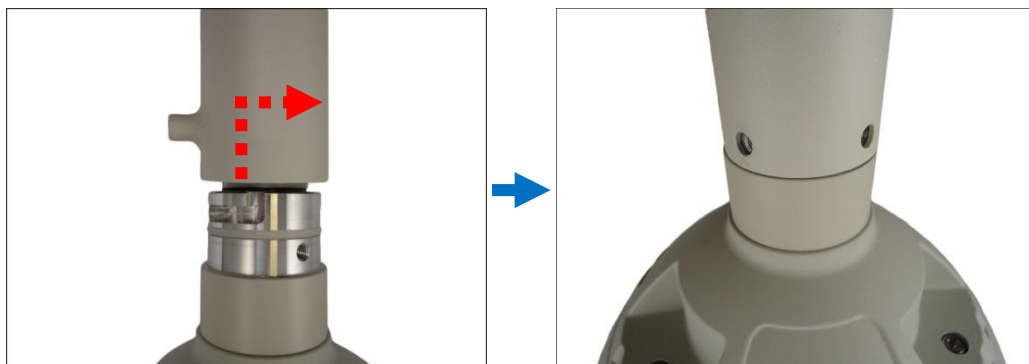

3. Twist the camera to align the screw holes and attach the two (2) mounting screws (included in the camera package).



4. For I9x models, attach the safety wire strap for added protection; see [How to Attach the Safety Wire Strap \(For I9x Models\)](#) on page 30.
5. Remove the plastic covering the dome cover.

Below is a sample installation.



Step 4: Connect the Cables





The camera itself is waterproof, however take note that the cable connections are not.

If the camera is mounted directly on the wall where the cables pass through the wall, then your installation is complete and you do not need to waterproof the cable connections.

However, if the camera is mounted where the cables may be exposed then it is recommended to waterproof the cable connections or use a junction box.





The camera comes with a **Cable Gland** and **Conduit Gland**. It is recommended to use one of these glands when a high PoE injector will be used with the camera. However, if the bundled power adapter will be used or digital input/output devices will be connected, it is recommended to house the cables inside the junction box (see [Straight Tube with Junction Box Installation Procedures](#) on page 18).

Determine the type of waterproof solution applicable to your installation environment requirements and prepare the necessary accessories or purchase extra materials.

Cable Gland	Conduit Gland
 <p>For use with an exterior-grade Ethernet cable (not included in the package).</p>  <p>See How to Waterproof the Cable Using the Cable Gland on page 10.</p>	 <p>For use with 1/2" flexible conduit (not included in the package).</p>  <p>See How to Waterproof the Cable Using the Conduit Gland on page 14.</p>

How to Waterproof the Cable Using the Cable Gland

1. Prepare the following items:

Cable Gland	Gland Rubber Ring	Exterior-Grade Ethernet Cable	Waterproof Tape
 <p>NOTE: The washer will not be used in this installation, please set it aside.</p>		 <p>NOTE: Not included in the camera package.</p>	 <p>NOTE: Not included in the camera package.</p>

2. Detach the cable gland as shown below.



3. Insert the clamping nut through the Ethernet cable.



4. Insert the Ethernet cable through the sealing rubber and claw.



5. Attach one (1) supplied rubber ring on the gland body (smooth end).

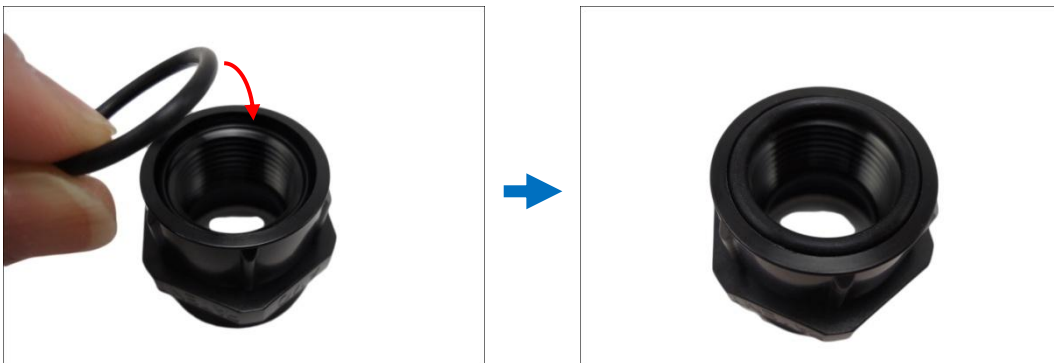

NOTE: Make sure the rubber ring is completely aligned on the gap on the gland body.

6. Attach the gland body to the Ethernet port of the camera.

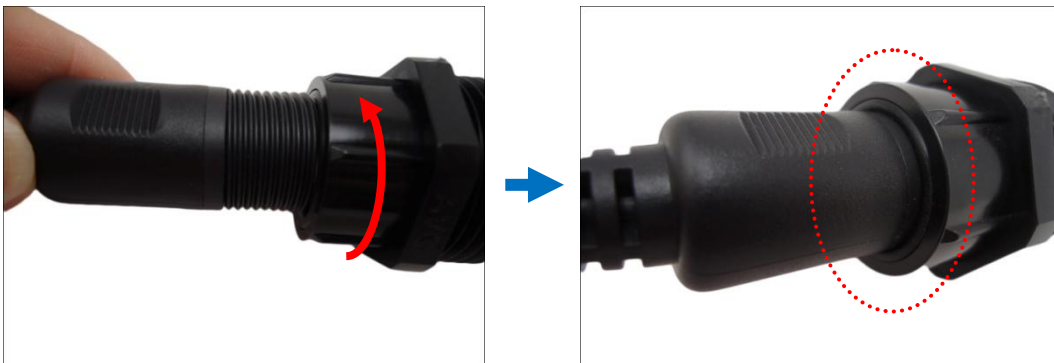

IMPORTANT!

Make sure the rubber ring is completely aligned and flat on the gland body to avoid possible water leakage.

7. Connect the Ethernet connector to the Ethernet port of the camera.



8. Insert the sealing rubber and claw into the cable gland body.

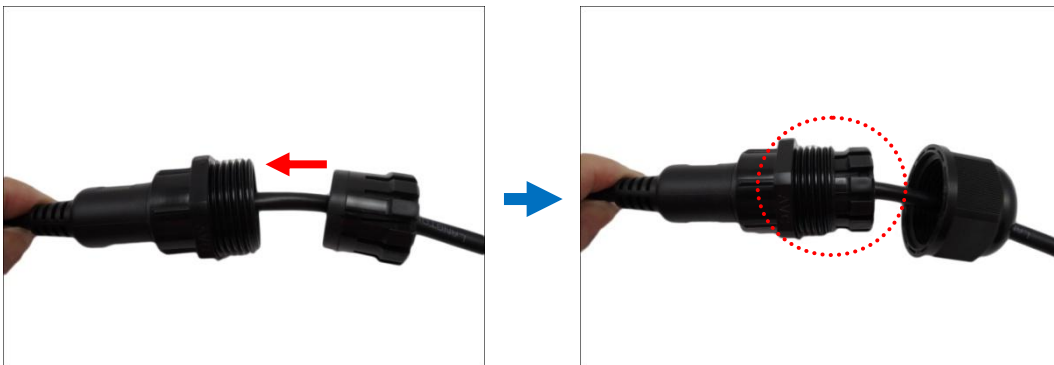

9. Attach the clamping nut to the cable gland body. Make sure the clamping nut is tightly secured and the rubber is squeezed in to avoid water leakage.

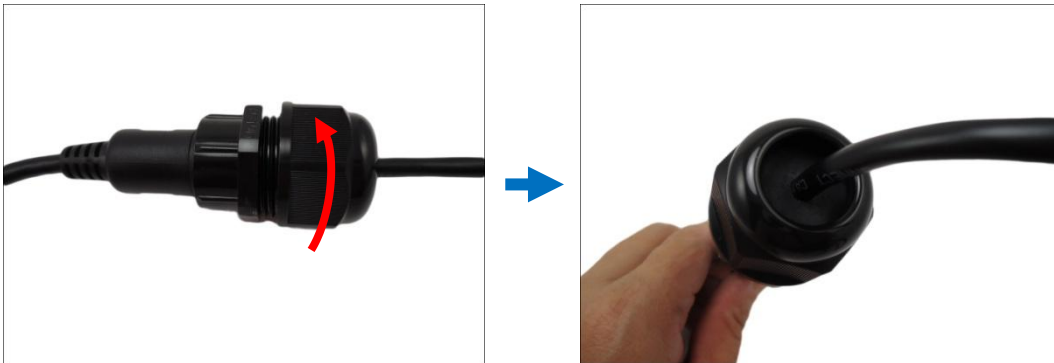

10. If necessary, connect the colored wires to digital input or output (DI/DO) devices to trigger events or notifications. Make sure to waterproof the cable connection (e.g. wrap with waterproof tape).

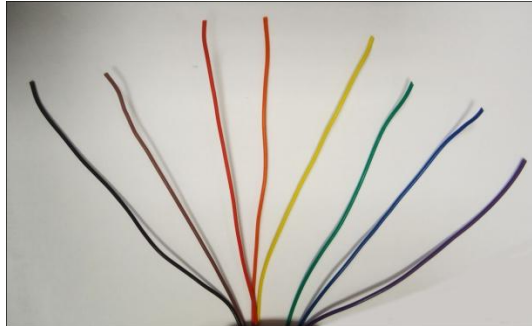

NOTE: Follow the wiring instructions described in the Camera Hardware Manual downloadable from the website (www.acti.com).

11. Arrange all unused cables and wrap them with the waterproof tape.

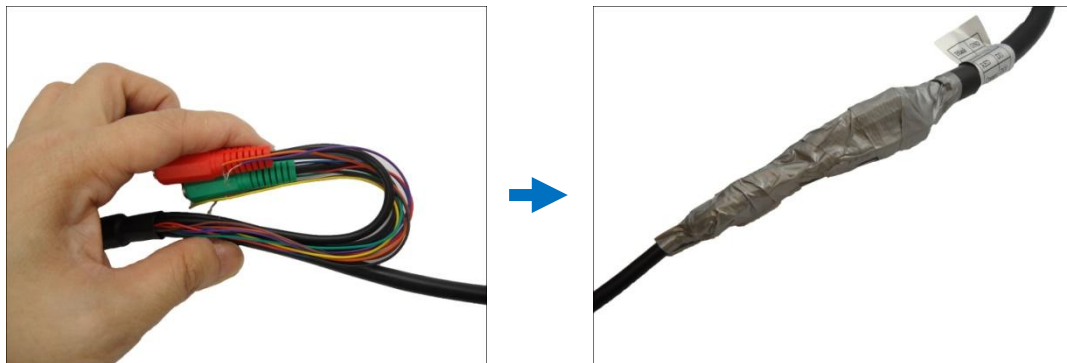





NOTE:

- Different applications and installation environments require different types of waterproofing methods which may not be covered in this manual. Check your installation environment and adapt a suitable waterproofing method.
- If the camera is installed outdoors and the bundled power adapter is used or input/output devices are connected, be sure to protect them from different environmental factors. It is recommended to place the cable connections indoors or housed them inside a junction box (see *[Straight Tube with Junction Box Installation Procedures](#)* on page 18).

DISCLAIMER: ACTi will not be responsible for camera damage caused by improper use of the power adapter.

How to Waterproof the Cable Using the Conduit Gland

1. Prepare the following items:

Cable Gland	Gland Rubber Ring	1/2" Flexible Conduit	Waterproof Tape
 <p>NOTE: The washer will not be used in this installation, please set it aside.</p>		 <p>NOTE: Not included in the camera package.</p>	 <p>NOTE: Not included in the camera package.</p>

2. Detach the conduit gland as shown below.



3. Insert the Ethernet cable through the flexible conduit. Then insert the clamping nut through the flexible conduit.



4. Insert the sealing rubber and attach it at the end of the flexible conduit.



5. Attach one (1) supplied rubber ring on the gland body (smooth end).

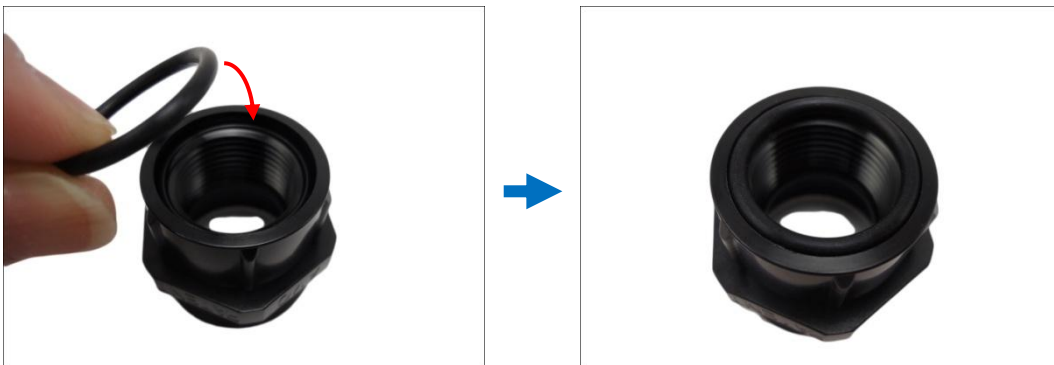

NOTE: Make sure the rubber ring is completely aligned on the gap on the gland body.

6. Attach the gland body to the Ethernet port of the camera.

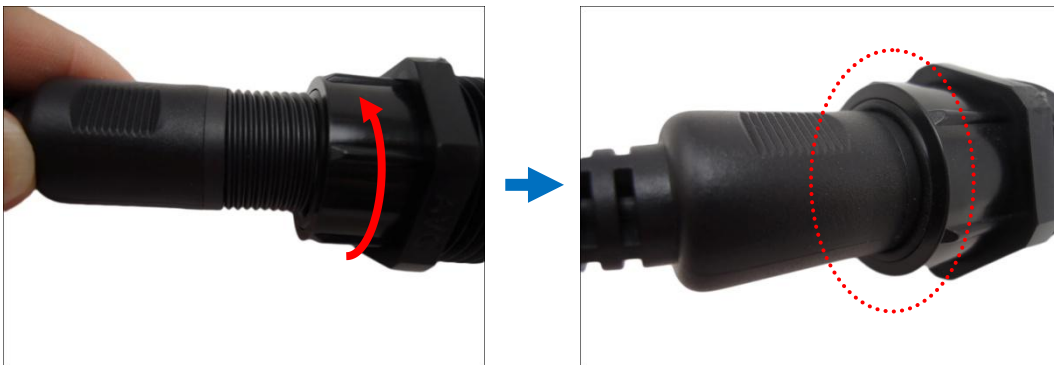

IMPORTANT!

Make sure the rubber ring is completely aligned and flat on the gland body to avoid possible water leakage.

7. Connect the Ethernet connector to the Ethernet port of the camera.



8. Insert the sealing rubber into the conduit gland body.

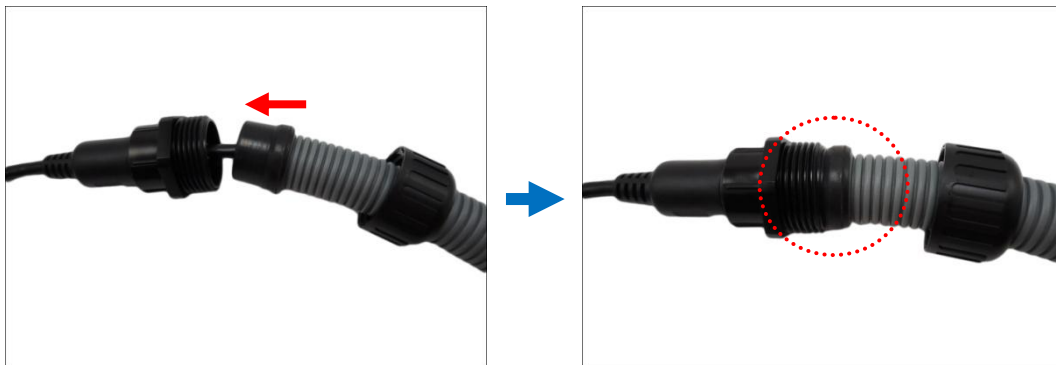

9. Attach the clamping nut to the conduit gland body. Make sure the clamping nut is tightly secured to avoid water leakage.



10. If necessary, connect the colored wires to digital input or output (DI/DO) devices to trigger events or notifications.

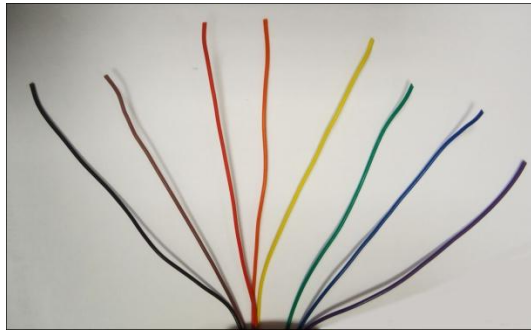

NOTE: Follow the wiring instructions described in the Camera Hardware Manual downloadable from the website (www.acti.com).

11. Arrange all unused cables and wrap them with the waterproof tape.

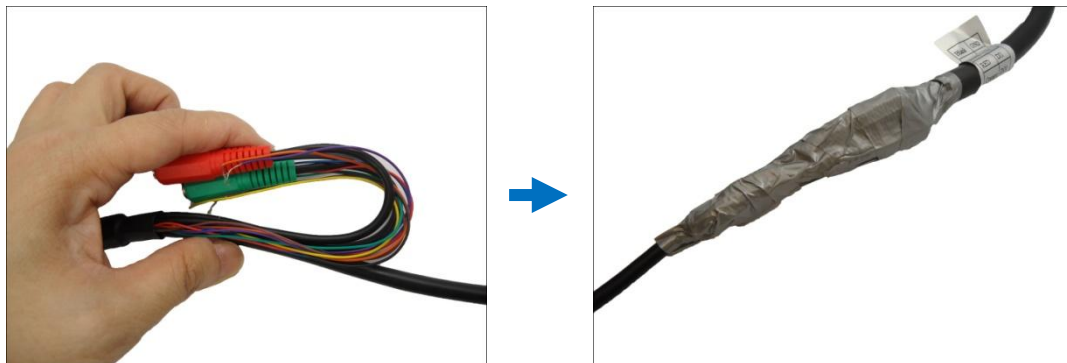

NOTE:

- Different applications and installation environments require different types of waterproofing methods which may not be covered in this manual. Check your installation environment and adapt a suitable waterproofing method.
- If the camera is installed outdoors and the bundled power adapter is used or input/output devices are connected, be sure to protect them from different environmental factors. It is recommended to place the cable connections indoors or housed them inside a junction box (see [Straight Tube with Junction Box Installation Procedures](#) on page 18).

DISCLAIMER: ACTi will not be responsible for camera damage caused by improper use of the power adapter.

Straight Tube with Junction Box

Installation Procedures

Perform the following procedures to install the camera onto a hard ceiling using pendant mount with a junction box. Cables can be routed to pass through the ceiling or along the ceiling and into the junction box.

This type of installation is ideal when using the bundled power adapter and power cord to ensure they are protected from different types of weather conditions.

Before installation, prepare the tools and equipment which are not supplied with the mounting accessory:

- Ethernet Cables
- Flexible Conduit with Conduit Gland (Size 3/4")

NOTE: Below is an example of a common conduit gland with flex conduit available in the market. Actual items sold in your area may vary.

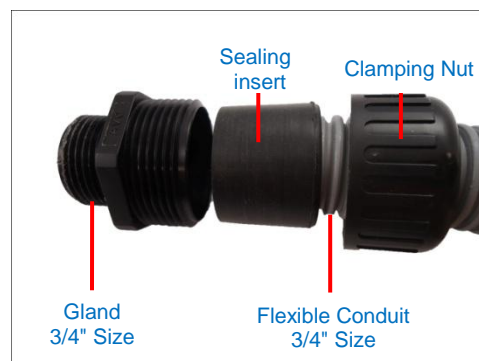

For use with the bundled power adapter and power cord, prepare also the following equipment:

- Female-type Socket
- Male-type Plug
- Power Cable without connectors (length depends on the distance of the power supply outlet and installation site)
- Electrical tape

Step 1: Unpack the Camera

NOTE: To avoid scratches or leaving fingerprints on the dome cover, it is recommended to retain the plastic covering the dome cover until the camera is completely installed.

1. Loosen the four screws using the bundled Allen wrench.



2. Carefully lift the camera cover and place it aside.

NOTE: The cover is attached to the camera by a metallic wire; do not abruptly lift the cover.



3. Remove the outer and inner Styrofoam.



Outer Styrofoam



Inner Styrofoam

4. Attach the camera cover.

Align the cover screws to the screw holes on the camera (as marked on the illustration) and secure the screws using the bundled Allen wrench.



Step 2: Unpack the Junction Box

1. Determine how the cables will be routed:

- If the cables will pass through a hole in the ceiling, remove one or two of the rear metal cap(s) as needed.
- If the cables will go along the ceiling, remove one or two side metal cap(s).

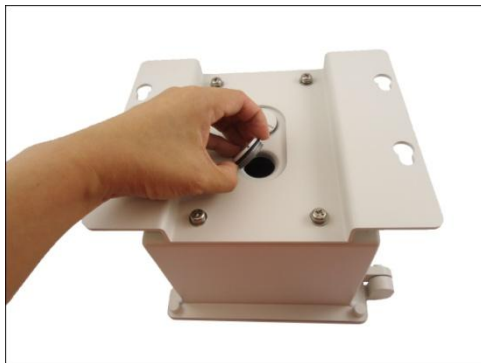

Rear Side Metal Caps

or



Side Metal Caps

2. Remove the four (4) screws securing the side door.

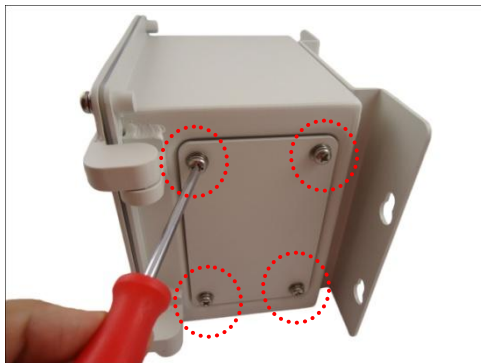

Step 3: Drill the Holes on the Ceiling

NOTE: Before installation, make sure that the ceiling can bear more than the total weight of the camera and the mounting accessories.

Using the drill template (included in the junction box package), mark and drill the locations of the screw holes and one or two conduit holes (as needed) on the ceiling. The conduit hole is where the cables will pass through the ceiling.

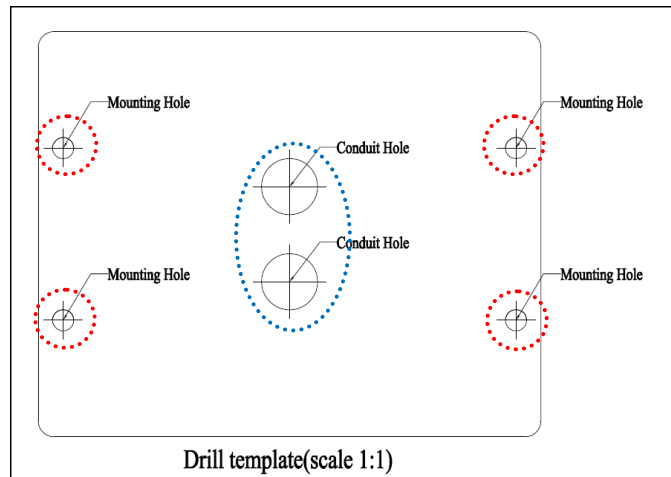

Step 4: Waterproof the Cables

1. Insert the cables, such as the network cable, power cable without connectors (if using the bundled power adapter and power cord), etc., through a flex conduit (not included in the package).

NOTE: Only a power cable fits through the conduit hole of the junction box; thus the installation of a power outlet to the power cable must be done inside the junction box.



2. **If the cables will pass through the ceiling**, attach the conduit gland body to one of the rear holes of the junction box. **If cables will be routed along the ceiling**, skip to **Step 5: Install the Junction Box** on page 23.



3. Insert the cables through the hole and tightly attach the clamping nut to the conduit gland body.

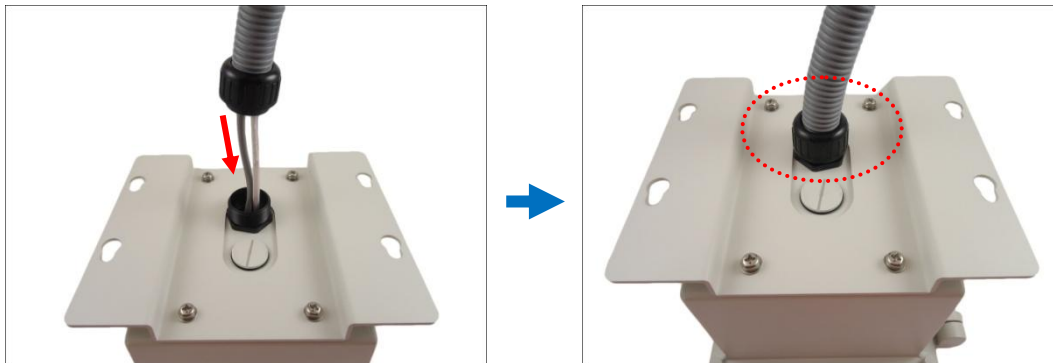

⚠ CAUTION: Make sure the clamping nut is securely attached to the conduit gland body to avoid water leak, etc.

DISCLAIMER: The manufacturer will not be responsible for damage caused by water leak from incorrect cabling methods.

Step 5: Install the Junction Box

1. Attach the junction box onto the ceiling using four (4) screws (purchased separately).

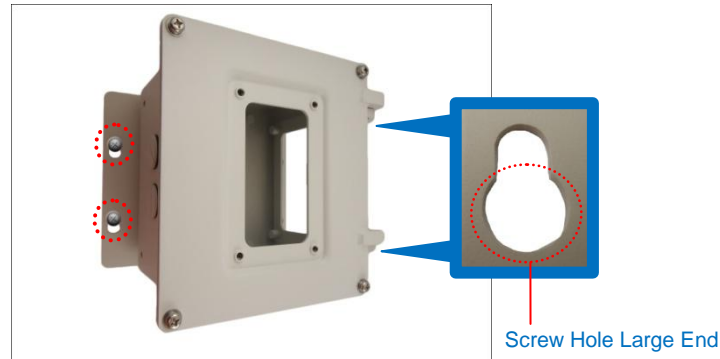

NOTE:

- Use screws with screw heads bigger than the diameter of the large screw holes on the junction box.
 - Make sure the junction box is tightly screwed on the wall to avoid possible shifting of the junction box position due to the PTZ camera movements.
2. **If the cables pass through the ceiling**, skip to [Step 6: Install the Straight Tube](#) on page 24.

If the cables will be routed along the ceiling, attach the conduit gland body to one of the side holes of the junction box.



3. Insert the cables into the side hole and tightly attach the clamping nut to the conduit gland body.

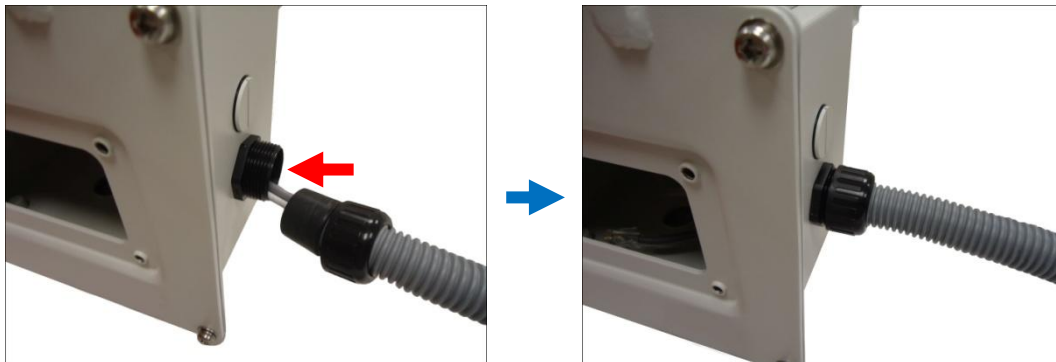

⚠ CAUTION: Make sure the clamping nut is securely attached to the conduit gland body to avoid water leak, etc.

DISCLAIMER: The manufacturer will not be responsible for damage caused by water leak from incorrect cabling methods.

Step 6: Install the Straight Tube

Attach the straight tube to the junction box using the four (4) screws included in the straight tube package.



Optional: Add Extension Tube(s)

If the straight tube is not long enough, add one or more extension tubes (purchased separately). If more than one extension tubes will be used, use extension cables (e.g. network) to extend the length of the pre-installed camera cables. See [How to Install Extension Tubes](#) on page 28.

Step 7: Install the Camera

1. Insert the camera cables through the straight tube, extension tube (if any), and into the junction box.



2. Align the slot on the camera to the tab inside the straight tube and insert the top of the camera.

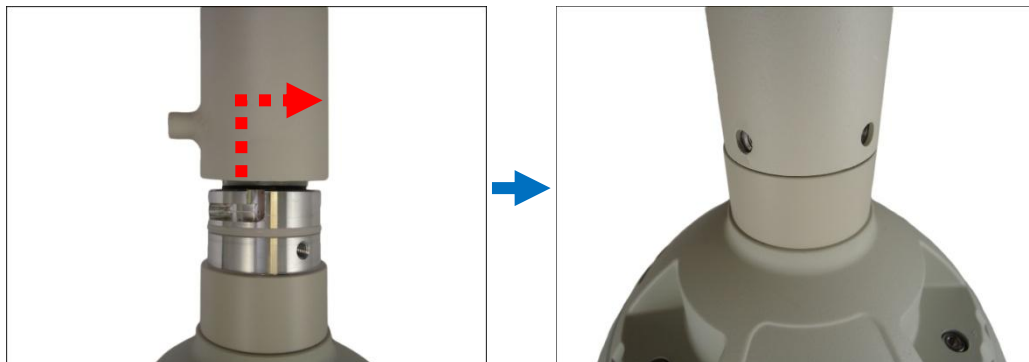

3. Twist the camera to align the screw holes and attach the two (2) mounting screws (included in the camera package).



4. For I9x models, attach the safety wire strap for added protection; see [How to Attach the Safety Wire Strap \(For I9x Models\)](#) on page 30.
5. Remove the plastic covering the dome cover.

Below is a sample installation.



Step 8: Connect the Cables

Inside the junction box, perform the following:

1. Connect the bundled power adapter and power cord and place them inside the junction box.
For I9x models, see [How to Use the Power Adapter \(For I9x Models\)](#) on page 29 for more information on using the power adapter.
2. Connect the Ethernet cable from the network side to the Ethernet port of the camera.



- If necessary, connect the colored wires to digital input or output (DI/DO) devices to trigger events or notifications.

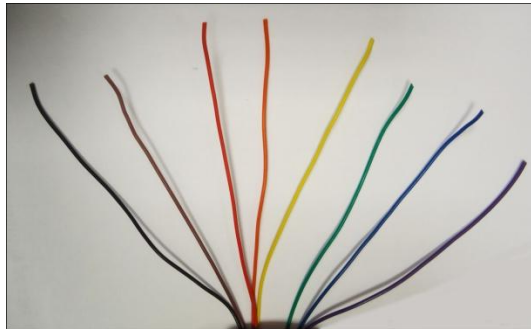

NOTE: Follow the wiring instructions described in the Camera Hardware Manual downloadable from the website (www.acti.com).

- Attach the female-type socket to the power cable in the junction box, and connect the power cord to the socket.

NOTE:

- Only a power cable fits through the conduit hole of the junction box; thus the installation of a power outlet to the power line cable must be done inside the junction box.
- Use only the supplied power adapter and power cord that came with the camera or the optional High PoE Injector (PPOE-0110). Using other accessories not approved by the manufacturer may cause damage to the equipment.

- Close the junction box door using the four (4) screws supplied with the junction box.

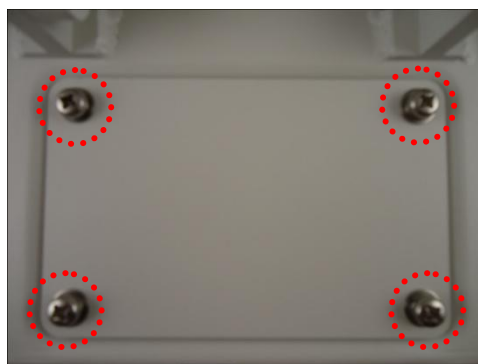

NOTE: Make sure the side is door is tightly sealed to ensure water does not enter the junction box.

- On the network side, connect the other end of the Ethernet cable to a network switch.
- On the power supply side, attach the male-type plug on the other end of the power cable, and then connect it to a power outlet.

Appendices

How to Install Extension Tubes

If the Straight Tube is not long enough, add one or more extension tubes (purchased separately).

1. Remove the two (2) pre-installed screws on the extension tube.

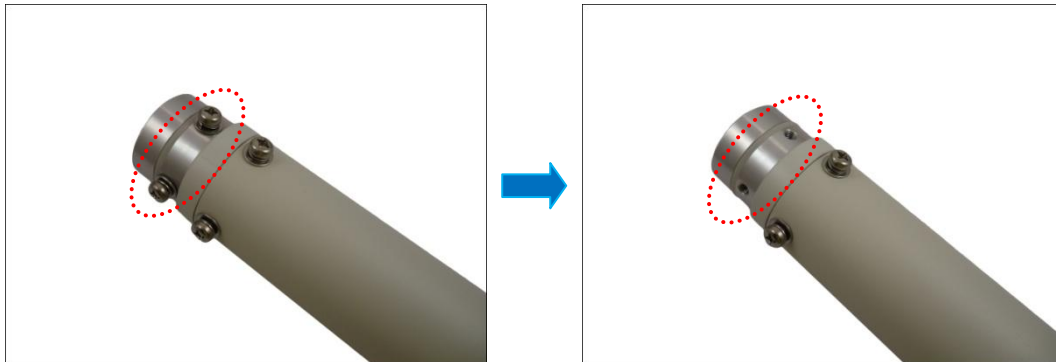

2. Insert the cable into the extension tube.
3. Align the slot on the extension tube to the tab inside the Straight Tube and install the extension tube.

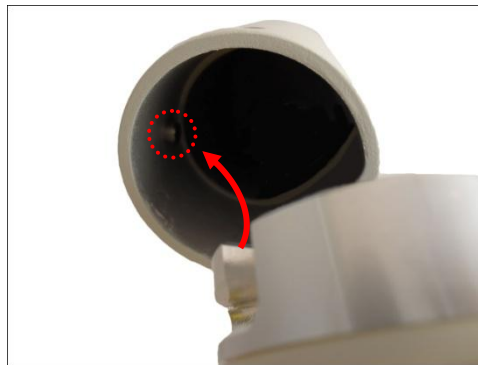

4. Twist the extension tube to align the screw holes and reattach the two (2) mounting screws removed from step 1.

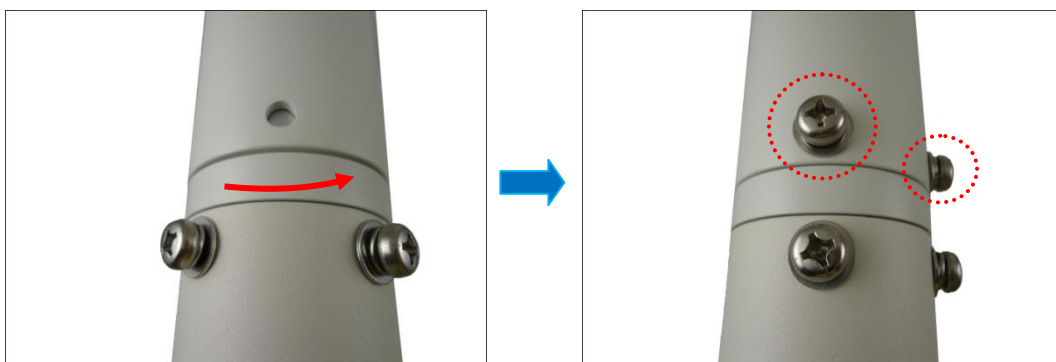

How to Use the Power Adapter (For I9x Models)

1. Slide the voltage switch to set the adapter voltage according to the voltage standard in your location.
2. Connect the power cord to the power adapter.



3. Connect the power connector of the camera to the cable connector of the adapter.

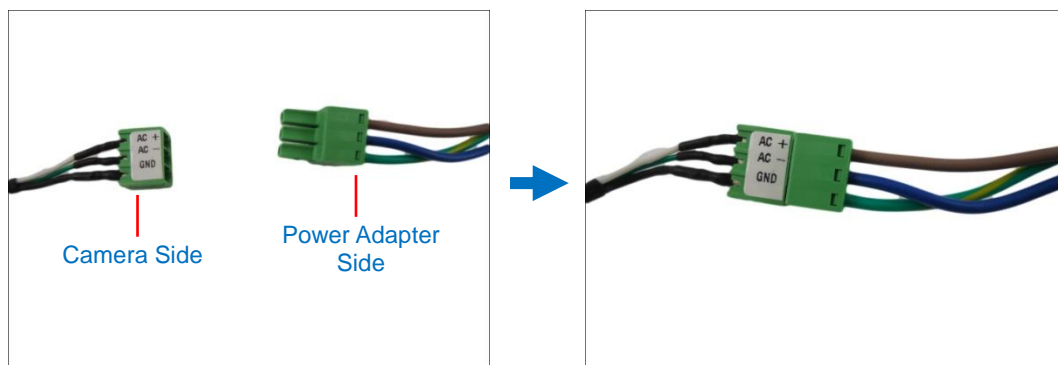

How to Attach the Safety Wire Strap (For I9x Models)

Most of ACTi's mounting accessories have a safety screw where the bundled safety wire strap can be used as additional protection to avoid dropping the camera while mounted on the high ceilings, etc.

To attach the safety wire strap, do the following:

1. Using a screwdriver, remove the screw on top of the camera.

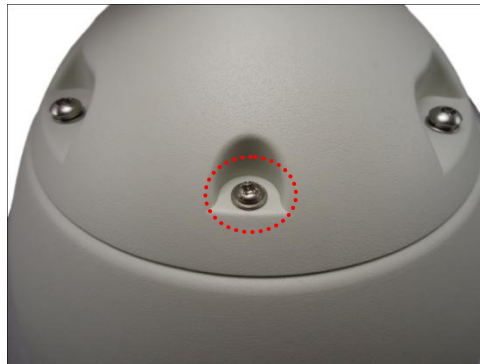

2. Insert the screw through the smaller end of the safety wire strap and attach it to the camera.

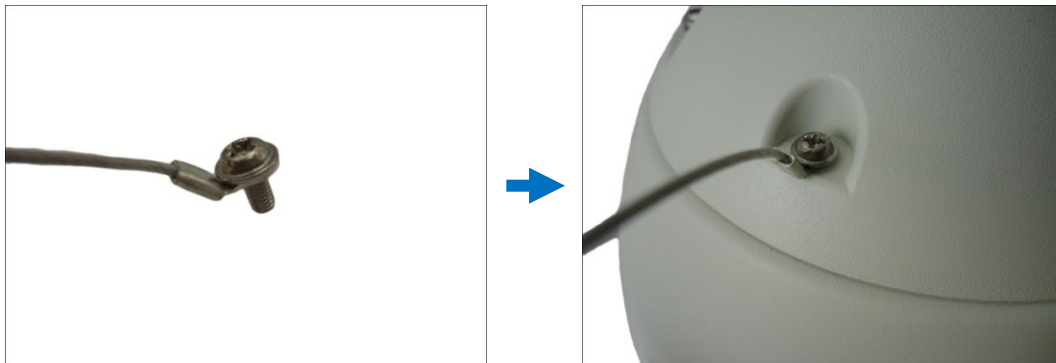

3. Remove the safety screw from the mounting solution (below is an example of the straight tube).

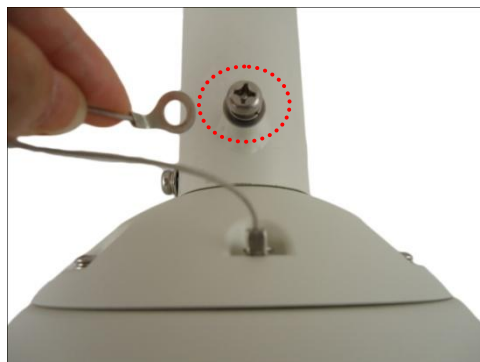

4. Align the bigger end of the safety wire strap on the mounting solution and then tightly attach the screw to lock the safety wire strap in place.

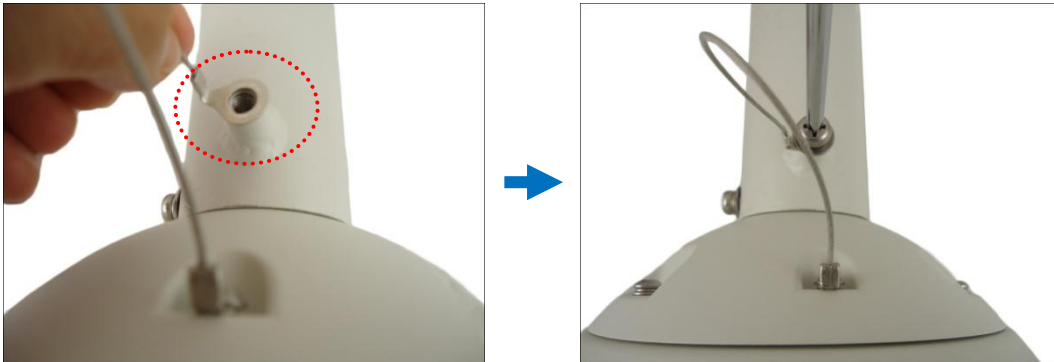

Safety Information

Read these instructions

You should read all the safety and operating instructions before using this product.

Heed all warnings

You must adhere to all the warnings on the product and in the instruction manual. Failure to follow the safety instruction given may directly endanger people, cause damage to the system or to other equipment.

Trademarks

All names used in this manual are probably registered trademarks of respective companies.

Liability

Every reasonable care has been taken during the writing of this manual. Please inform your local office if you find any inaccuracies or omissions. We cannot be held responsible for any typographical or technical errors and reserve the right to make changes to the product and manuals without prior notice.

Cleaning

Disconnect this video product from the power supply before cleaning.

Attachments

Do not use attachments not recommended by the video product manufacturer as they may cause hazards.

Do not use accessories not recommended by the manufacturer

Only install this device in a dry place protected from weather

Servicing

Do not attempt to service this video product yourself. Refer all servicing to qualified service personnel.

Damage Requiring service

Disconnect this video product from the power supply immediately and refer servicing to qualified service personnel under the following conditions.

- 1) When the power-supply cord or plug is damaged
- 2) If liquid has been spilled, or objects have fallen into the video product.
- 3) If the inner parts of video product have been directly exposed to rain or water.
- 4) If the video product does not operate normally by following the operating Instructions in this manual. Adjust only those controls that are covered by the instruction manual, as an improper adjustment of other controls may result in damage, and will often require extensive work by a qualified technician to restore the video product to its normal operation.

Safety Check

Upon completion of any service or repairs to this video product, ask the service technician to perform safety checks to determine if the video product is in proper operating condition.